



MODEL N° 90114

OWNER'S MANUAL

COPY

Keep this Product ID Number and use when contacting Customer Service:

REGISTER YOUR LIFETIME PRODUCT TODAY!

There are benefits to registering your Lifetime product. With our new online product registration form, it's fast and easy! Register with us at www.lifetime.com and enjoy these great benefits:

- Receive exclusive money-saving offers from BuyLifetime.com, our online store, as well as NEW product notifications and special closeout promotions!
- In the unlikely event of a product recall or safety modification, we will notify you.
- Registering your product guarantees you warranty service. If you do not register your product, your warranty rights will not be diminished. But you will need to provide a sales receipt to verify your product purchase date before warranty service will be provided.

LIFETIME'S PROMISE TO YOU:

Maintaining your privacy is our long-standing policy at Lifetime. And you can rest assured that Lifetime will not sell or provide your personal data to other third parties, or allow them to use your personal data for their own purposes.

We invite you to read our privacy policy at www.lifetime.com

REGISTER today!

Save this owner's manual for future reference and in the event that the manufacturer has to be contacted.

****U.S. and Canada customers ONLY****

IF ASSISTANCE IS NEEDED,

DO NOT CONTACT THE STORE!

CALL OUR CUSTOMER SERVICE DEPARTMENT at

1 (800) 225-3865

HOURS: 7:00 a.m. to 5:00 p.m. Monday through Friday (Mountain Standard Time)

Call us or visit our Web site for Saturday hours

Lifetime Products, Inc.

PO Box 160010 • Freeport Center, Bldg. D-11 Clearfield, Utah 84016-0010

For customers outside the U.S. or Canada, please contact the store for assistance.



SAFETY INSTRUCTIONS



FAILURE TO FOLLOW THESE WARNINGS MAY RESULT IN SERIOUS INJURY OR PROPERTY DAMAGE AND WILL VOID WARRANTY.

To ensure safety, do not attempt to assemble this product without reading and following all instructions carefully. Check the entire box and inside all packing materials for parts and/or additional instruction material. Before beginning assembly, identify and inventory all parts and hardware using the parts and hardware lists and identifiers in this document. Proper and complete assembly, use and supervision are essential for proper orientation and to reduce the risk of accident or injury. A high probability of serious injury exists if this product is not installed, maintained, and/or operated properly. Failure to comply with any of the warnings in this instruction manual may result in serious personal injuries such as cuts, broken bones, nerve damage, paralysis, brain injury, or death. Failure to comply may also result in property damage. Please heed all warnings and cautions.

- If using a ladder during assembly, use extreme caution.
- Two capable adults are recommended for this operation.
- Check base daily for leakage. Leaks may cause product to fall.
- Assemble the pole sections properly. Failure to do so could cause the pole sections to separate during play or transport.

Most injuries are caused by misuse and/or not following instructions. Use caution when using this product.

BEFORE BEGINNING ASSEMBLY



Keep the hardware bags and their contents separate. If any parts are missing, call our Customer Service Department.



Identify and inventory all parts and hardware using the parts and hardware lists and identifiers in this document.



Test fit all Bolts by inserting them into their respective holes. If necessary, carefully scrape away any excess powder coating buildup from inside the holes. Do not scrape away all of the powder coating. Bare metal may rust. You may need to pound some Bolts into place with a hammer or mallet.



TOOLS AND PARTS REQUIRED FOR THIS ASSEMBLY

Adjustable Wrench

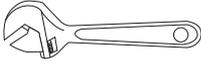

(2)

Phillips Screwdriver

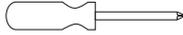

(1)

3/8" Socket Wrench



(1)

Scrap Wood



(1)

Funnel



(1)

Sand



(150 lb)

Water Hose



(1)

Rubber Mallet

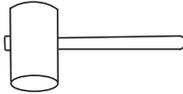

(1)



****Two adults required to complete assembly****

Only adults should set up the product. Do not allow children in the setup area until assembly is complete.

ASSEMBLY GUIDES

Refer to the following areas throughout the instructions to assist in the assembly process:

This area is located at the top, left-hand corner of the page and indicates which tools and hardware are needed to complete the assembly steps on a page.



TOOLS AND HARDWARE REQUIRED FOR THIS PAGE



This area is usually located in the bottom, left-hand corner of a step and indicates that special attention is needed to perform a particular part of a step.



Note:

These areas are usually located in the bottom, right-hand corner of a step and indicate that damage to the product or serious injury may occur if the caution or warning is not heeded.



CAUTION



WARNING

PARTS LIST

<u>ID</u>	<u>Item Description</u>	<u>Qty</u>	<u>✓</u>
ALH	Top Pole	1	<input type="checkbox"/>
ALF	Middle Pole	1	<input type="checkbox"/>
ALE	Bottom Pole	1	<input type="checkbox"/>
BFN	Adjustment Knob	1	<input type="checkbox"/>
BFQ	Pole Plug	1	<input type="checkbox"/>
AJI	Backboard	1	<input type="checkbox"/>
BFM	Backboard Brace	2	<input type="checkbox"/>
ALX	Rim	1	<input type="checkbox"/>
AKZ	Net	1	<input type="checkbox"/>
AJM	Base	1	<input type="checkbox"/>
ALI	Upper Pole Brace	2	<input type="checkbox"/>
ALK	Right Bottom Pole Brace	1	<input type="checkbox"/>
ALJ	Left Bottom Pole Brace	1	<input type="checkbox"/>
BDB	Cross Tube	1	<input type="checkbox"/>
BFO	Right Foot	1	<input type="checkbox"/>
BFP	Left Foot	1	<input type="checkbox"/>
AMU	Wheel	2	<input type="checkbox"/>
AMT	Warning Sticker (Applied to Middle Pole)	1	<input type="checkbox"/>

HARDWARE LIST

<u>ID</u>	<u>Item Description</u>	<u>Qty</u>	<u>✓</u>
	<i>Streamline Hardware</i>		
APN	5/16" Flange Lock Nut	1	<input type="checkbox"/>
APG	5/16" x 3 1/4" Hex Bolt	2	<input type="checkbox"/>
AOT	5/16" x 3 3/8" Hex Bolt	1	<input type="checkbox"/>
APP	5/16" x 4" Carriage Bolt	1	<input type="checkbox"/>
AAY	1/2" Nylock Jam Nut	1	<input type="checkbox"/>
AOR	1/2" Washer	1	<input type="checkbox"/>
AOS	1/2" x 6 1/4" Cap Screw	1	<input type="checkbox"/>
BFR	1/2" x 5 1/2" Axle	2	<input type="checkbox"/>
AAO	5/16" Nylock Nut	7	<input type="checkbox"/>
AOO	5/16" x 2" Hex Tap Bolt	2	<input type="checkbox"/>
AZY	Base Plug	2	<input type="checkbox"/>
APO	5/16" x 4 1/2" Carriage Bolt	1	<input type="checkbox"/>
APJ	5/16" x 3/4" Hex Bolt	2	<input type="checkbox"/>
COC	5/16" x 5/8" Screw for Plastic	2	<input type="checkbox"/>
AOL	5/16" x 3 1/4" Carriage Bolt	2	<input type="checkbox"/>
AOM	5/16" Cap Nut	2	<input type="checkbox"/>
ABD	5/16" Washer	15	<input type="checkbox"/>
AOP	M6 x 35 Phillips Pan Head Screw	2	<input type="checkbox"/>
AON	M6 x 1 Nylock Cap Nut	2	<input type="checkbox"/>
ADS	1/4" x 3/4" Screw	1	<input type="checkbox"/>
AOQ	3/8" Allen Wrench	1	<input type="checkbox"/>

PARTS IDENTIFIER

Parts shown at 10% of Actual Size

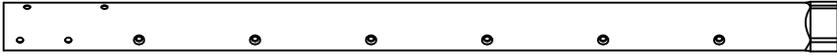

43"

ALH (x1)
Top Pole

*Do not remove Top Pole from Middle Pole until instructed



43"

ALF (x1)
Middle Pole



43"

ALE (x1)
Bottom Pole

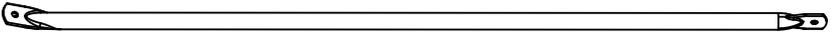

41"

ALI (x2)
Upper Pole Brace

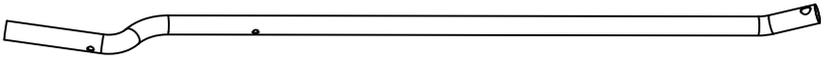

ALK (x1)
Right Bottom Pole Brace

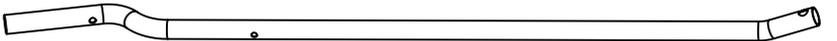

ALJ (x1)
Left Bottom Pole Brace



BDB (x1)
Cross Tube

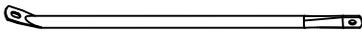

18 1/2"

BFM (x2)
Backboard Brace

PARTS IDENTIFIER

Parts shown at 10% of Actual Size

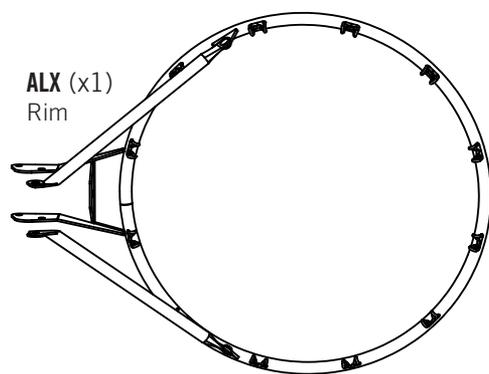

ALX (x1)
Rim

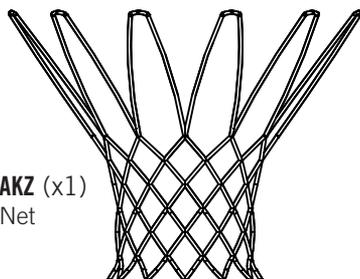

AKZ (x1)
Net

Parts shown at 5% of Actual Size

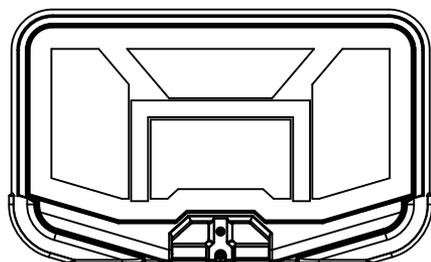

AJI (x1)
Backboard

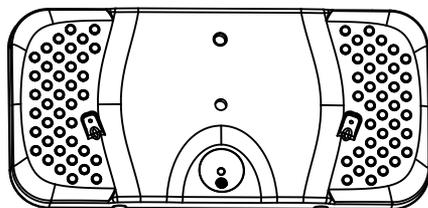

AJM (x1)
Base

Parts shown at 25% Actual Size

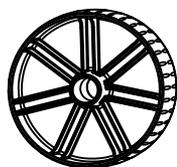

AMU (x2)
Wheel



BFQ (x1)
Pole Plug

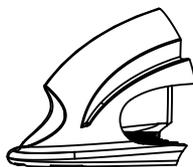

BFP (x1)
Left Foot

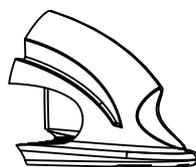

BFO (x1)
Right Foot

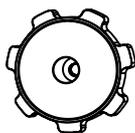

BFN (x1)
Adjustment Knob

HARDWARE IDENTIFIER

STREAMLINE HARDWARE (1069787)

Hardware shown at Actual Size

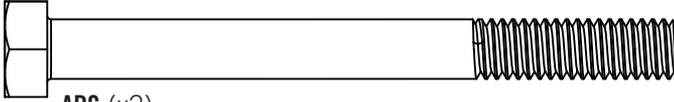

APG (x2)
5/16" x 3 1/4" Hex Bolt

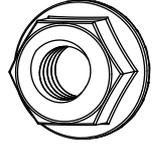

APN (x1)
5/16" Flange
Lock Nut

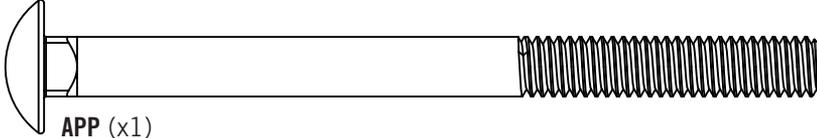

APP (x1)
5/16" x 4" Carriage Bolt

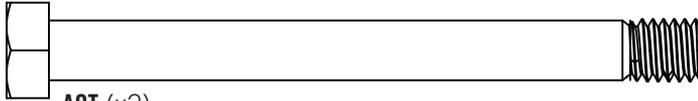

AOT (x2)
5/16" x 3 3/8" Hex Bolt



AAY (x1)
1/2" Nylock
Jam Nut

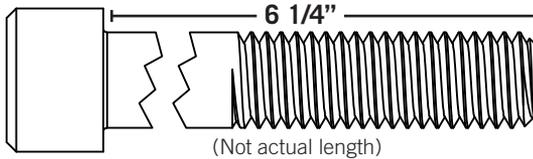

AOS (x1)
1/2" x 6 1/4" Cap Screw

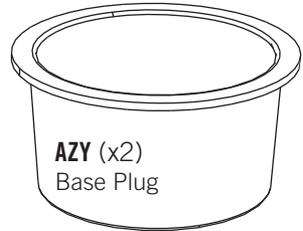

AZY (x2)
Base Plug

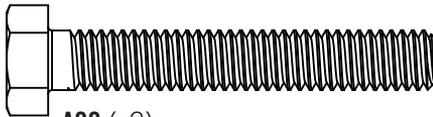

A00 (x2)
5/16" x 2" Hex Tap Bolt

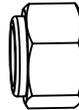

AAO (x7)
5/16" Nylock Nut

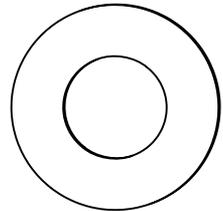

AOR (x1)
1/2" Washer

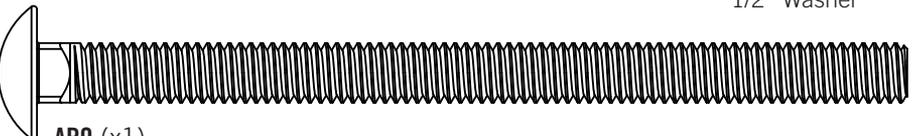

APO (x1)
5/16" x 4 1/2" Carriage Bolt

HARDWARE IDENTIFIER

STREAMLINE HARDWARE (CONTINUED)

Hardware shown at Actual Size

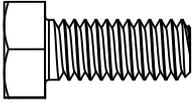

APJ (x2)
5/16" x 3/4" Hex Bolt

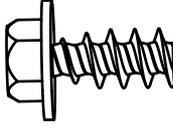

COC (x2)
5/16" x 5/8" Screw for Plastic

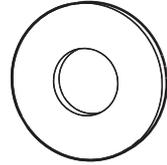

ABD (x15)
5/16" Washer

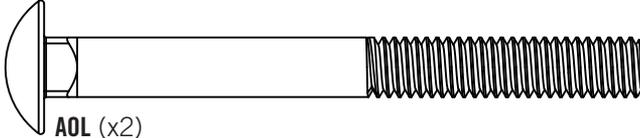

AOL (x2)
5/16" x 3 1/4" Carriage Bolt



AOM (x2)
5/16" Cap Nut

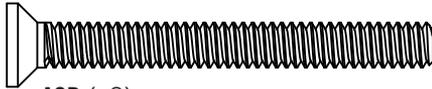

AOP (x2)
M6 x 35 Phillips Pan Head Screw



AON (x2)
M6 x 1 Nylock
Cap Nut

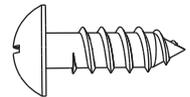

ADS (x1)
1/4" x 3/4" Screw

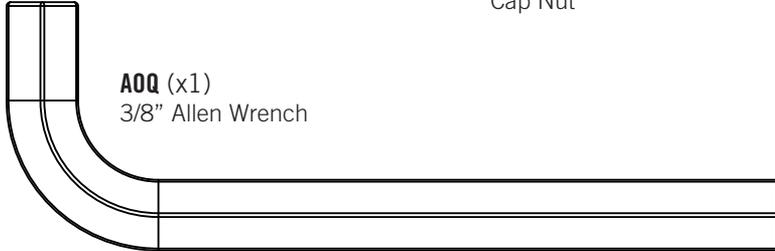

AQQ (x1)
3/8" Allen Wrench

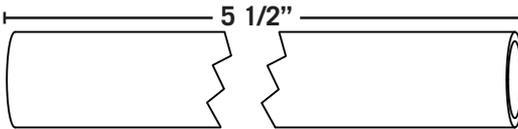

BFR (x2)
1/2" x 5 1/2" Axle
(Not actual length)

STEP 1 POLE ASSEMBLY

HARDWARE REQUIRED

Hardware shown at Actual Size

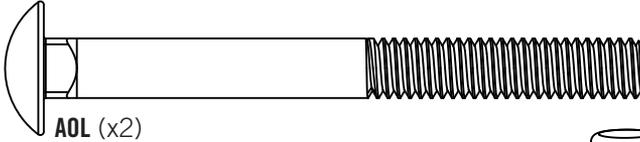

AOL (x2)
5/16" x 3 1/4" Carriage Bolt

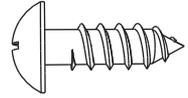

ADS (x1)
1/4" x 3/4" Screw



AOM (x1)
5/16" Cap Nut

PARTS REQUIRED

Parts shown at 10% of Actual Size

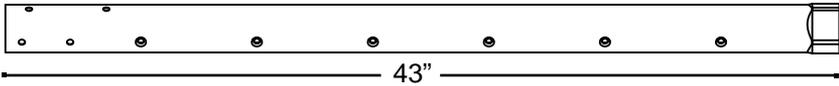

ALH (x1)
Top Pole

*Do not remove Top Pole from Middle Pole until instructed

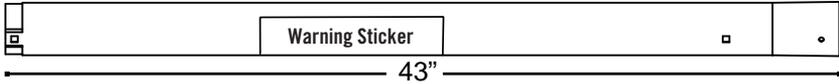

ALF (x1)
Middle Pole

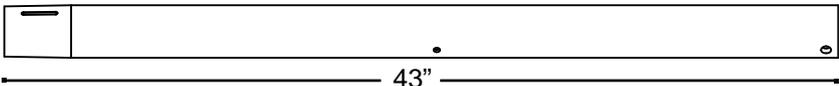

ALE (x1)
Bottom Pole

Part shown at 25% of Actual Size

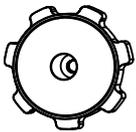

BFN (x1)
Adjustment Knob

TOOLS REQUIRED

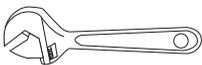

Adjustable Wrench (x2)

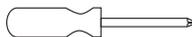

Phillips Screwdriver

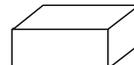

Scrap Wood



TOOLS AND HARDWARE REQUIRED FOR THIS PAGE

NO TOOLS OR HARDWARE REQUIRED FOR THIS PAGE

SEC

1.1

While the **Top Pole (ALH)** is still inside the **Middle Pole (ALF)**, pull the plastic off the Top Pole. It may be necessary to loosen the Poles before pulling out the plastic.

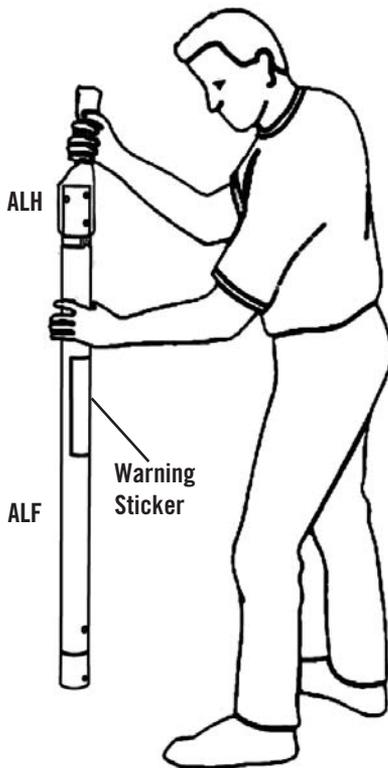



TOOLS AND HARDWARE REQUIRED FOR THIS PAGE

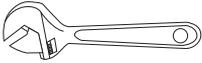

(x2)

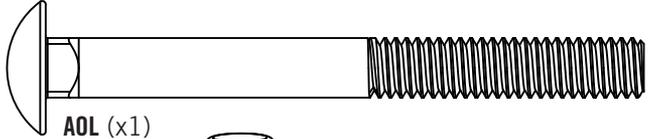

AOL (x1)

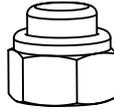

AOM (x1)

SEC

1.2

Slide the **Top Pole (ALH)** far enough out of the **Middle Pole (ALF)** so that it does not obstruct the holes at the bottom of the Middle Pole. Then attach the hardware indicated in the location shown.

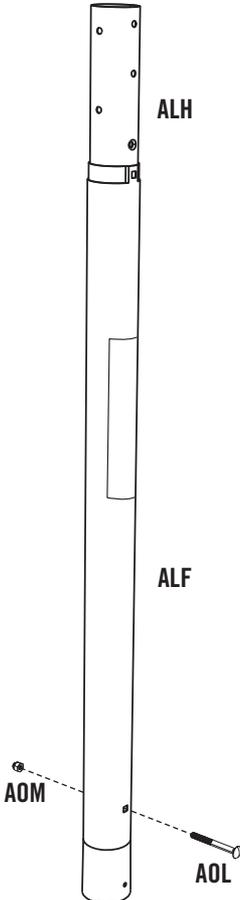

WARNING

Do not overtighten the Cap Nut. If the end of the Bolt breaks through the plastic cap, call our Customer Service Department. Exposed threads on the end of the Bolt may cause serious injuries.



TOOLS AND HARDWARE REQUIRED FOR THIS PAGE

NO TOOLS REQUIRED FOR THIS PAGE

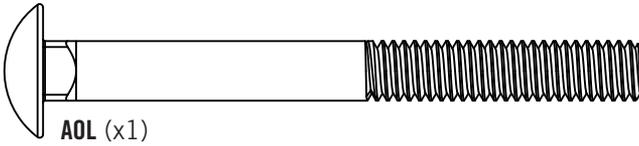

SEC

1.3

Position the **Top Pole (ALH)** at its lowest height and attach the **Adjustment Knob (BFN)** to the Top Pole and **Middle Pole (ALF)** with the hardware shown.

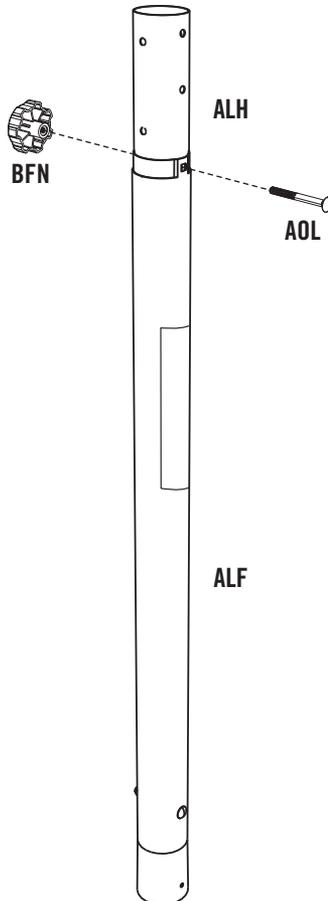



TOOLS AND HARDWARE REQUIRED FOR THIS PAGE

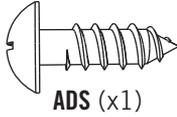
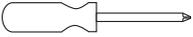

SEC

1.4

Align the hole in the **Middle Pole (ALF)** with the slot in the **Bottom Pole (ALE)** and slide the Middle Pole over the Bottom Pole. Insert a **1/4" x 3/4" Screw (ADS)** through the small hole in the Middle Pole into the slot in the Bottom Pole as shown.

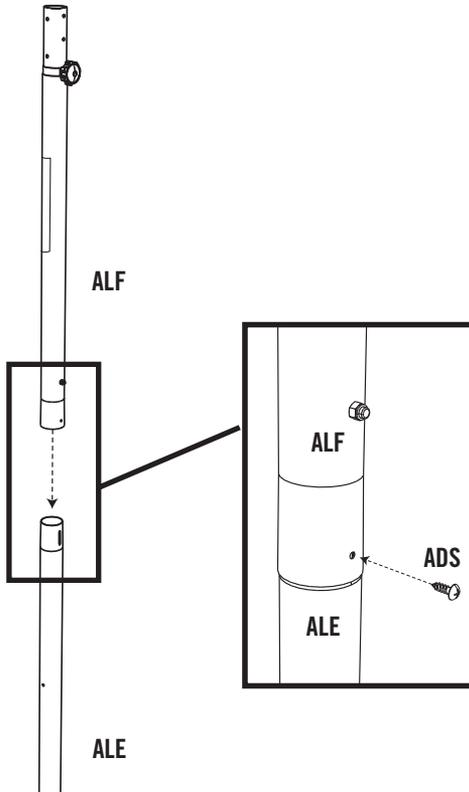

Note: The 1/4" x 3/4" Screw should be flush with the Pole, but will spin freely once installed. Do not jam the Poles together until instructed.



TOOLS AND HARDWARE REQUIRED FOR THIS PAGE

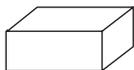

Scrap Wood

NO HARDWARE REQUIRED FOR THIS PAGE

SEC

1.5

ATTENTION: THIS STEP CANNOT BE REVERSED!

In order to seat the Poles, strike the end of the **Bottom Pole (ALE)** very hard five to six times on a piece of scrap wood or cardboard. This must be done even if the **Middle Pole (ALF)** covers the slot on the Bottom Pole before seating has occurred.

If the Middle Pole does not completely cover the slot on the Bottom Pole after seating has occurred, **DO NOT COMPLETE ASSEMBLY**. Call our Customer Service Department.



WARNING

The Poles must be seated together! Even if the Poles cover the slots before seating, they must be struck on a hard surface five to six times! Failure to seat the Poles correctly could allow the Poles to separate during use, which could lead to serious personal injuries or property damage.



Note: Do not hit your feet with the Pole sections, as serious injury could occur.

HARDWARE REQUIRED

Hardware shown at Actual Size

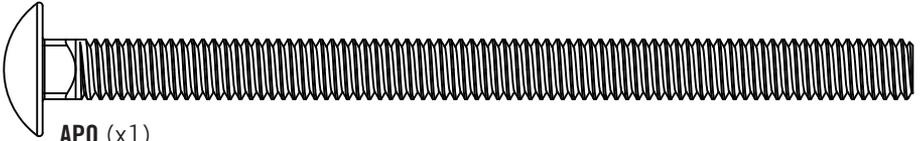

APO (x1)
5/16" x 4 1/2" Carriage Bolt

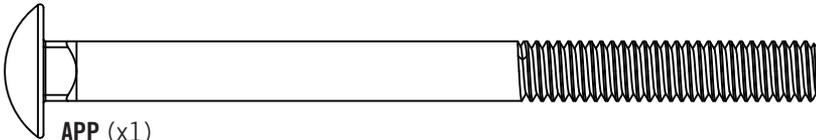

APP (x1)
5/16" x 4" Carriage Bolt

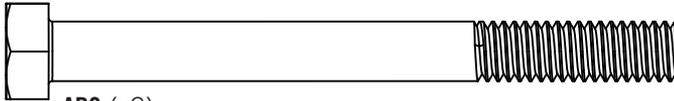

APG (x2)
5/16" x 3 1/4" Hex Bolt

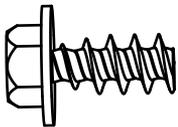

COC (x2)
5/16" x 5/8" Screw
for Plastic

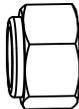

AAO (x5)
5/16" Nylock Nut



APN (x1)
5/16" Flange
Lock Nut

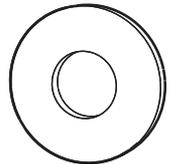

ABD (x9)
5/16" Washer

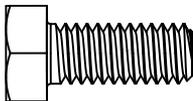

APJ (x2)
5/16" x 3/4" Hex Bolt

SEC 2 RIM & BACKBOARD TO POLE ASSEMBLY

PARTS REQUIRED

Parts shown at 10% of Actual Size

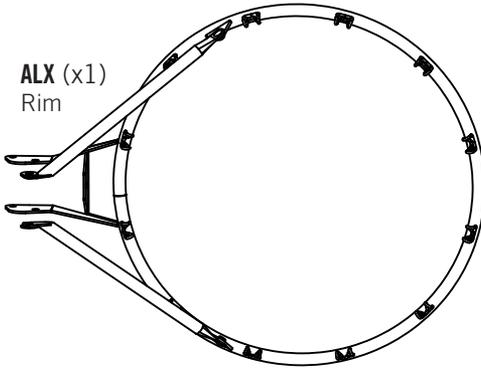

ALX (x1)
Rim

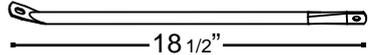

BFM (x2)
Backboard Brace

Part shown at 5% of Actual Size

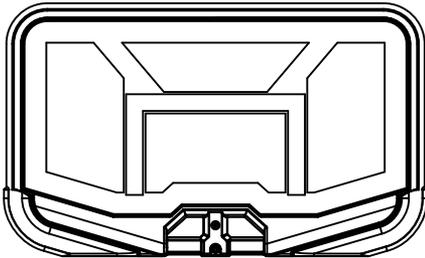

AJI (x1)
Backboard

TOOLS REQUIRED

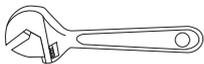

Adjustable Wrench (x2)



3/8" Socket Wrench (x1)



TOOLS AND HARDWARE REQUIRED FOR THIS PAGE

NO TOOLS OR HARDWARE REQUIRED FOR THIS PAGE

SEC

2.1

Insert Rim Brackets of the **Rim (ALX)** into the slots on the front of the **Backboard (AJI)**.

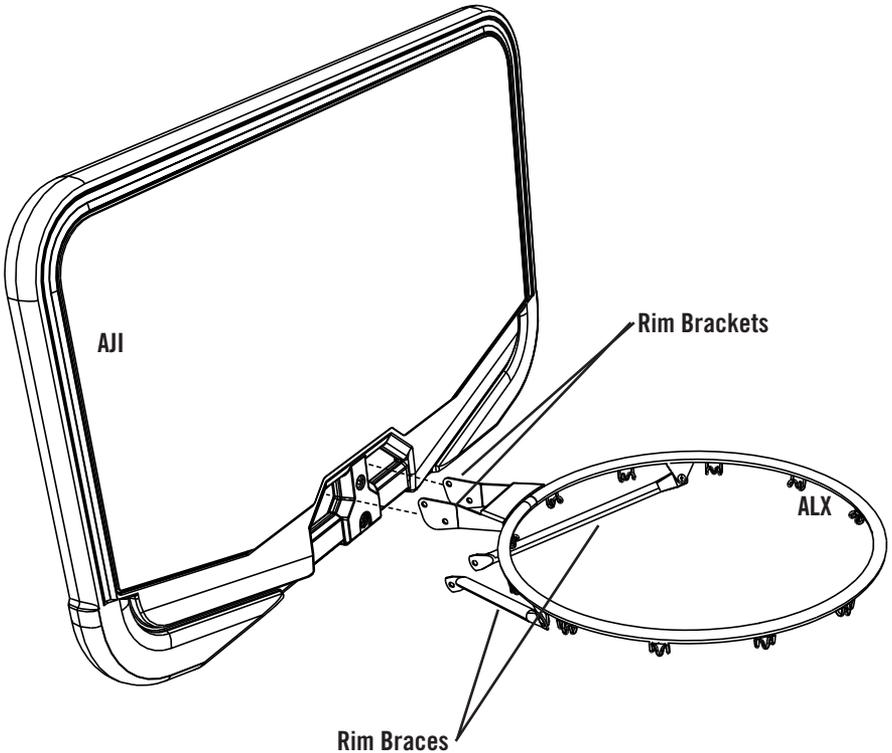

Note: The Rim Braces will remain outside of the Backboard slots as shown.



TOOLS AND HARDWARE REQUIRED FOR THIS PAGE

NO TOOLS OR HARDWARE REQUIRED FOR THIS PAGE

HAVE ONE ADULT HOLD THE BACKBOARD AND RIM ASSEMBLY UNTIL THIS SECTION HAS BEEN COMPLETED

SEC

2.2

Line up the holes in the **Top Pole (ALH)** with the holes in the **Backboard (AJI)** as shown and place the Top Pole between the Rim Brackets.

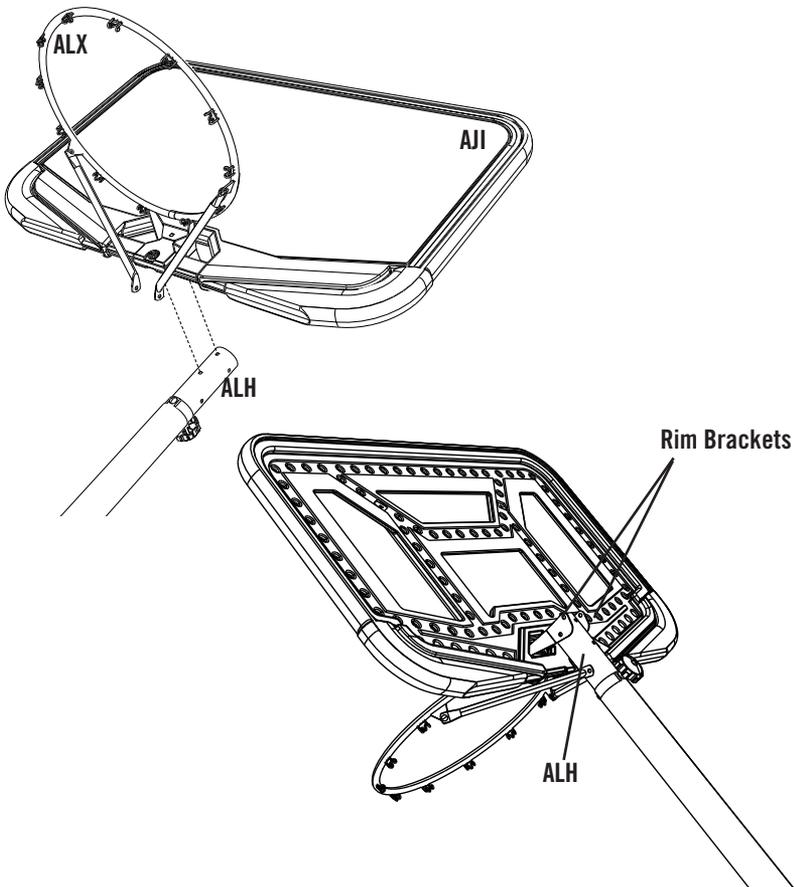



TOOLS AND HARDWARE REQUIRED FOR THIS PAGE

NO TOOLS REQUIRED FOR THIS PAGE

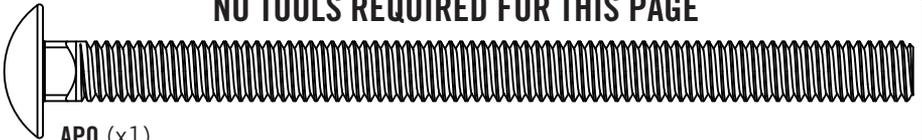

APO (x1)

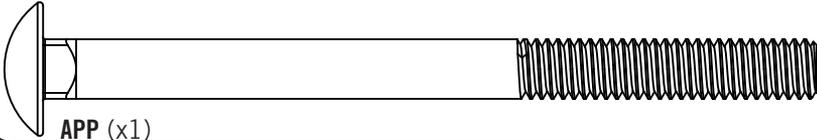

APP (x1)

SEC

2.3

Insert the **5/16" x 4 1/2" Carriage Bolt (APO)** through the **Rim (ALX)** in the hole indicated, and insert the Bolt into the upper hole on the **Backboard (AJI)** and into the **Top Pole (ALH)**. Also insert the **5/16" x 4" Carriage Bolt (APP)** through the bottom hole in the Backboard and into the Top Pole.

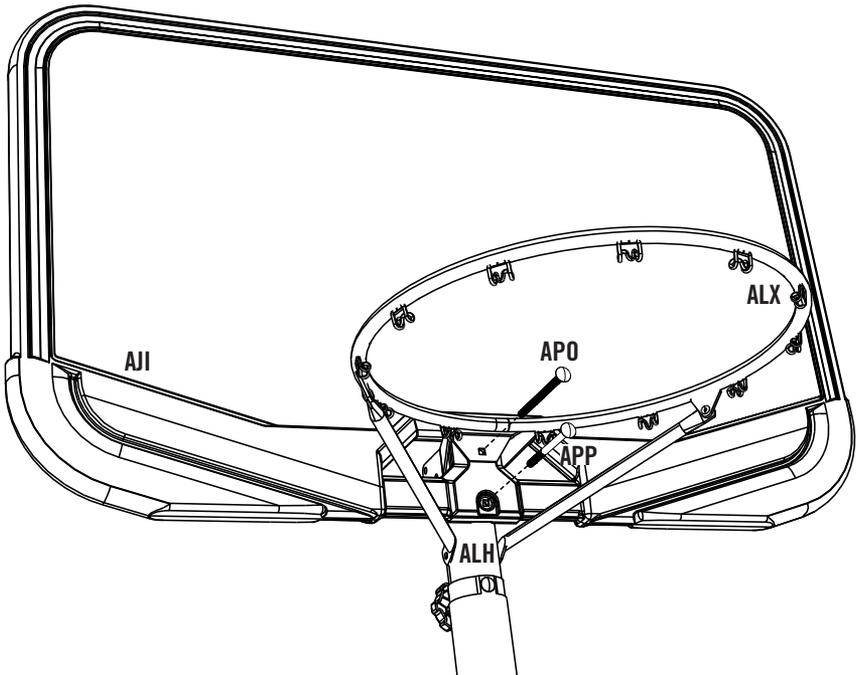



TOOLS AND HARDWARE REQUIRED FOR THIS PAGE

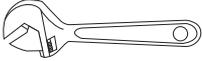

(x1)

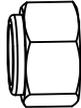

AAO (x1)



APN (x1)

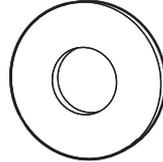

ABD (x1)

SEC

2.4

Attach the **Rim (ALX)** to the **Backboard (AJI)** and **Top Pole (ALH)** by securing a **5/16" Nylock Nut (AAO)** with a **5/16" Washer (ABD)** onto the **5/16" x 4 1/2" Carriage Bolt (APO)**. Also secure a **5/16" Flange Lock Nut (APN)** onto the **5/16" x 4" Carriage Bolt (APP)**.

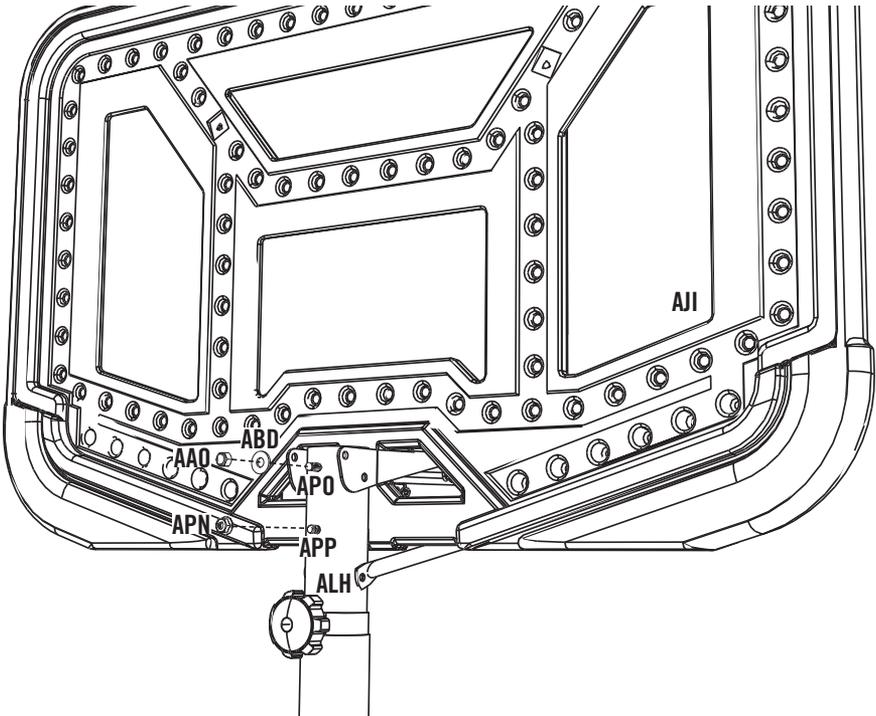

*Note: Tighten all hardware until it is flush with the Pole.
Do not overtighten the hardware.*



TOOLS AND HARDWARE REQUIRED FOR THIS PAGE

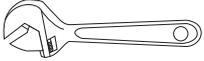

(x2)



APG (x2)

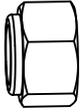

AAO (x2)

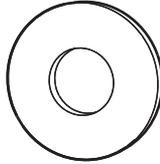

ABD (x4)

SEC

2.5

Secure the Rim Brackets and Rim Braces to the **Top Pole (ALH)** with the hardware shown.

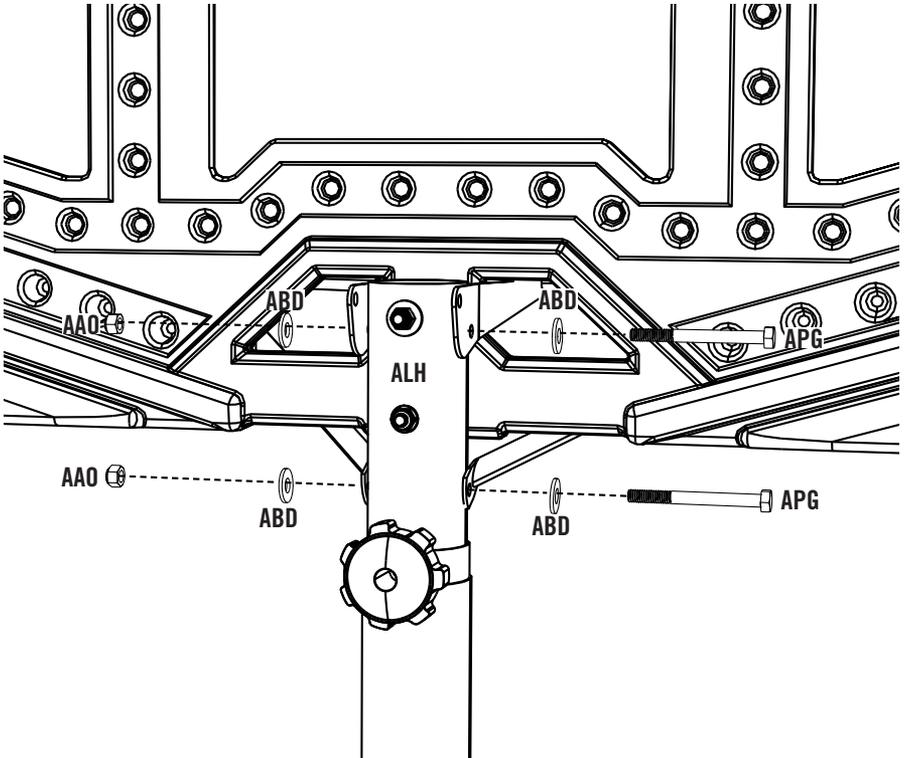



TOOLS AND HARDWARE REQUIRED FOR THIS PAGE

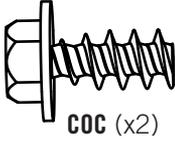
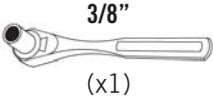

SEC

2.6

Secure a **Backboard Brace (BFM)** to the **Backboard (AJI)** using the hardware shown. **Do not overtighten the hardware.**

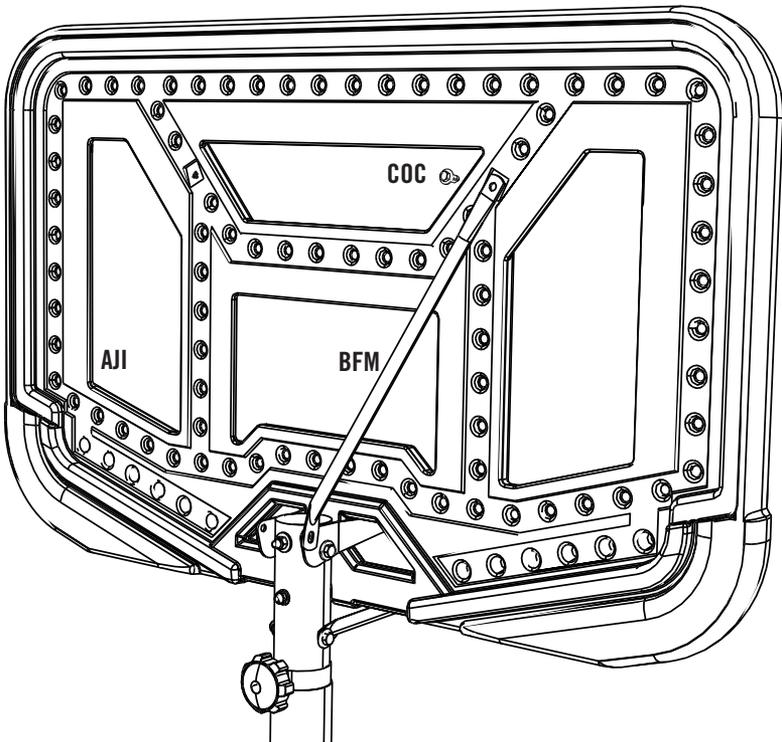



TOOLS AND HARDWARE REQUIRED FOR THIS PAGE



(x2)



APJ (x2)

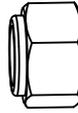

AAO (x2)

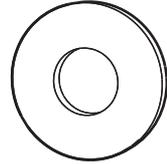

ABD (x4)

SEC

2.7

Attach the **Backboard Brace (BFM)** from Sec 2.7 to the Rim Brackets with the hardware shown. Repeat Sec 2.6 and 2.7 to attach the other **Backboard Brace** to the Backboard and Rim Brackets.

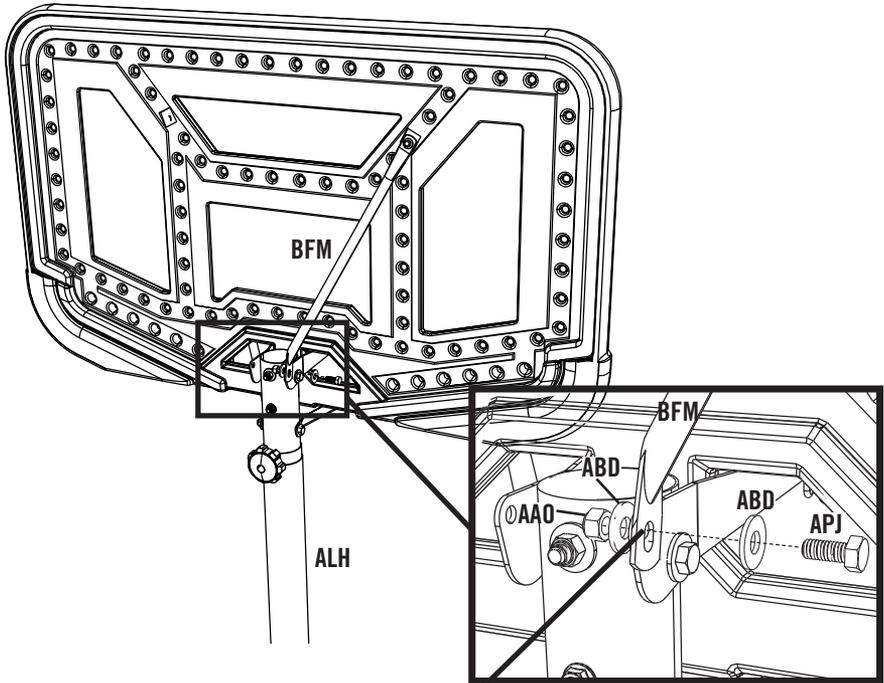

Note: The hole in the Backboard Brace is slotted. Secure Bolt (APJ) through the top of the slotted hole in order to install the Backboard correctly.



Note: Lay the assembly on the ground with the Rim (ALX) facing upward and the Backboard (AJI) tilted on its side.

SEC 3 POLE TO BASE ASSEMBLY

HARDWARE REQUIRED

Hardware shown at Actual Size

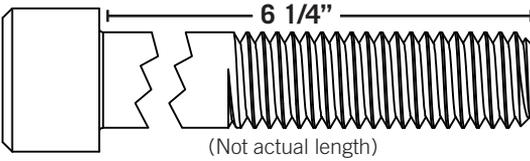

AOS (x1)
1/2" x 6 1/4" Cap Screw

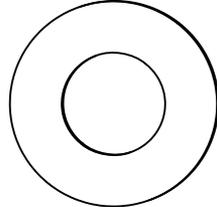

AOR (x1)
1/2" Washer

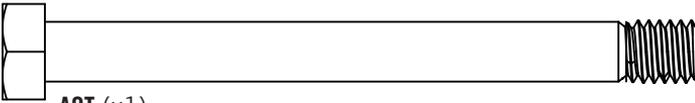

AOT (x1)
5/16" x 3 3/8" Hex Bolt

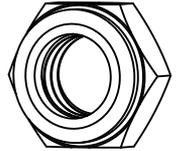

AAY (x1)
1/2" Nylock
Jam Nut

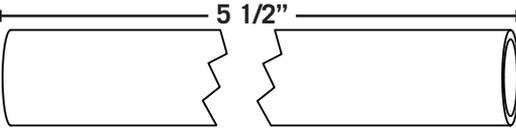

BFR (x2)
1/2" x 5 1/2" Axle

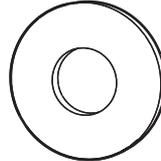

ABD (x6)
5/16" Washer

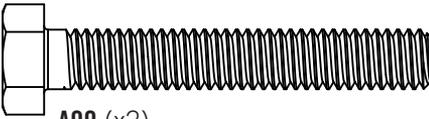

A00 (x2)
5/16" x 2" Hex Tap Bolt



A0M (x1)
5/16" Cap Nut



A0N (x2)
M6 x 1 Nylock
Cap Nut

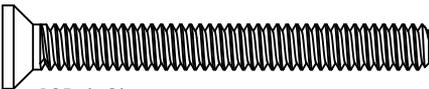

A0P (x2)
M6 x 35 Phillips Pan Head Screw

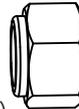

A0A (x2)
5/16" Nylock Nut

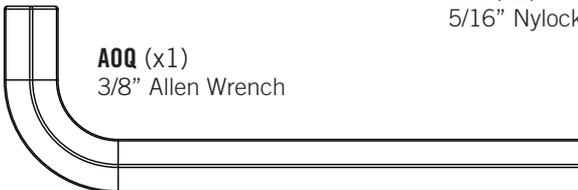

A0Q (x1)
3/8" Allen Wrench

3 POLE TO BASE ASSEMBLY

PARTS REQUIRED

Parts shown at 10% of Actual Size

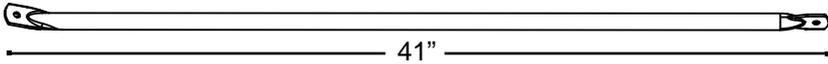

ALI (x2)
Upper Pole Brace

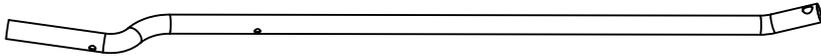

ALK (x1)
Right Bottom Pole Brace

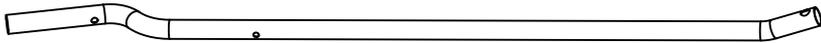

ALJ (x1)
Left Bottom Pole Brace

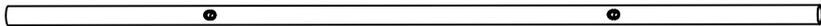

BDB (x1)
Cross Tube

Parts shown at 25% of Actual Size

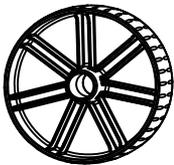

AMU (x2)
Wheel



BFQ (x1)
Pole Plug

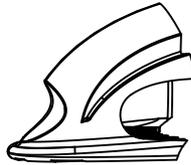

BFP (x1)
Left Foot



BFO (x1)
Right Foot

Part shown at 5% of Actual Size

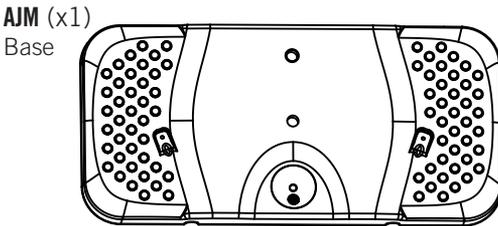

AJM (x1)
Base

TOOLS REQUIRED

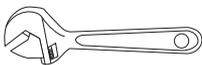

Adjustable Wrench (x2)

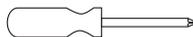

Phillips Screwdriver



TOOLS AND HARDWARE REQUIRED FOR THIS PAGE

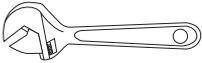

(x1)

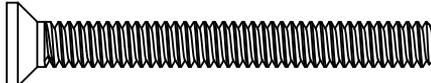

AOP (x2)



AON (x2)

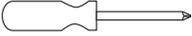

SEC

3.1

Attach the **Cross Tube (BDB)** to the **Left and Right Bottom Pole Braces (ALJ & ALK)** with the hardware shown.

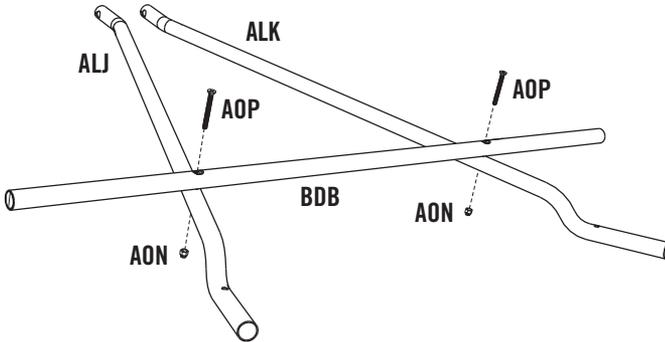

WARNING

Do not overtighten the Cap Nut.

SEC

3.2

Fit the Bottom Pole Brace Assembly within the recesses on the underside of the **Base (AJM)** as shown.

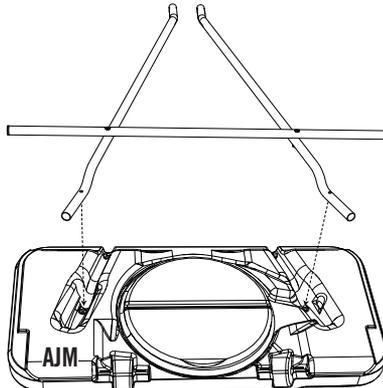



TOOLS AND HARDWARE REQUIRED FOR THIS PAGE

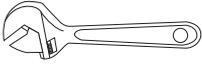

(x2)

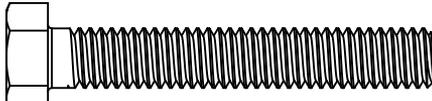

AOO (x2)

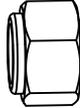

AAO (x2)

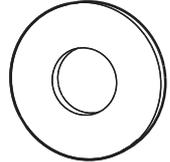

ABD (x4)

SEC

3.3

Attach the **Upper Pole Braces (ALI)** to the **Base (AJM)** and the Bottom Pole Brace Assembly with the hardware shown.

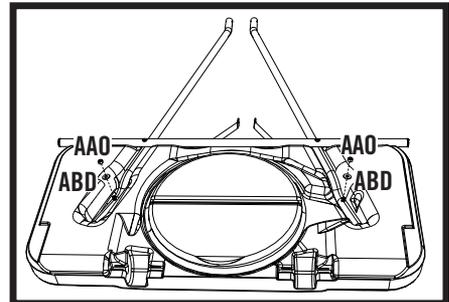
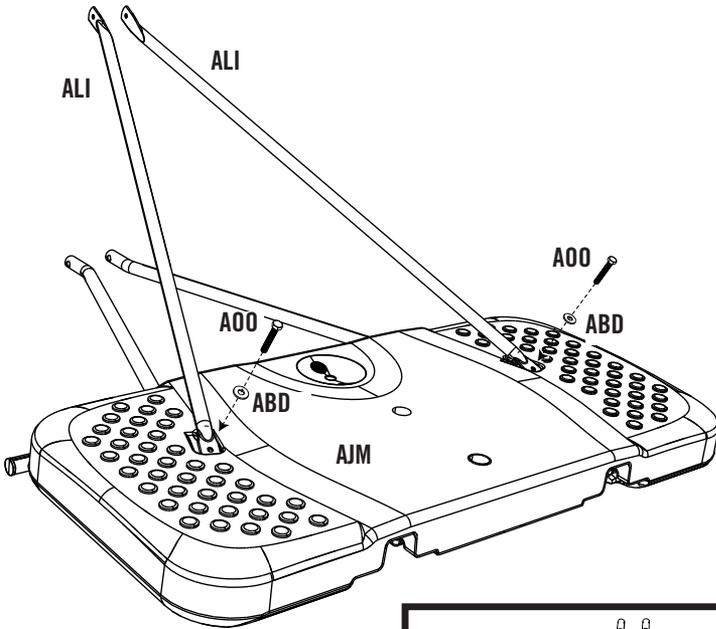

Underside View of Base



TOOLS AND HARDWARE REQUIRED FOR THIS PAGE

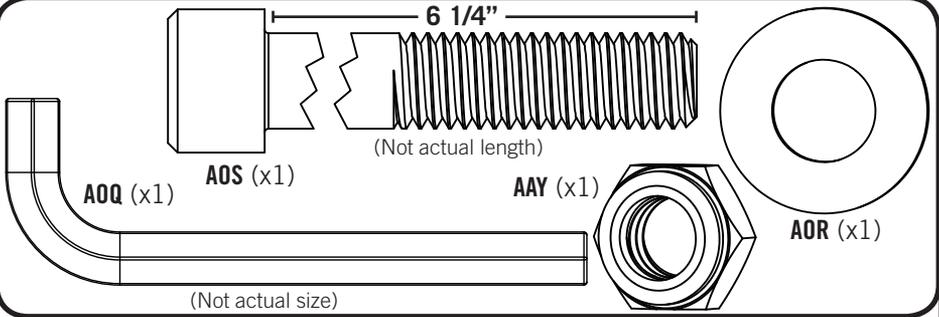

CAUTION: HAVE ONE ADULT HOLD THE POLE UNTIL THE BASE HAS BEEN FILLED WITH SAND OR WATER



SEC

3.4

Insert the **Pole Plug (BFQ)** into the **Bottom Pole (ALE)** in the orientation shown. With the system at its upright position, attach the **Left and Right Bottom Pole Braces (ALJ & ALK)** and the **Left and Right Feet (BFP & BFO)** to the Bottom Pole with the hardware shown.

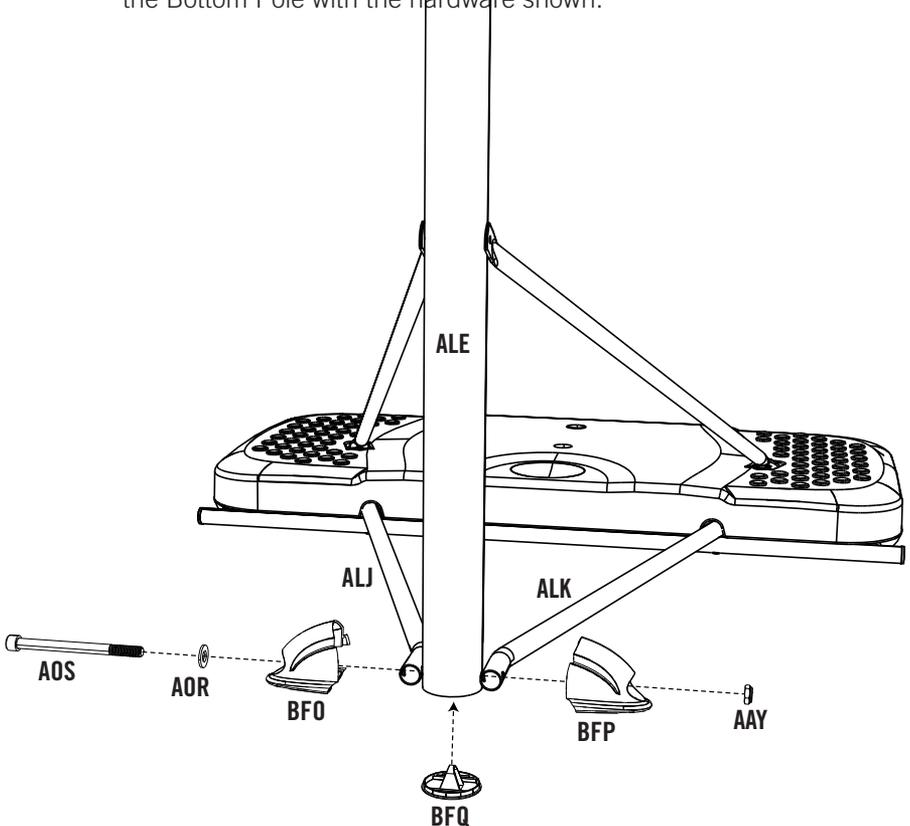



TOOLS AND HARDWARE REQUIRED FOR THIS PAGE

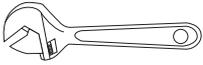

(x2)

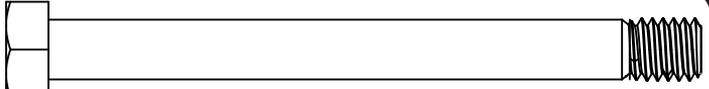

AOT (x1)



AOM (x1)

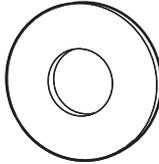

ABD (x2)

SEC

3.5

Attach the **Upper Pole Braces (ALI)** to the **Bottom Pole (ALE)** with the hardware shown.

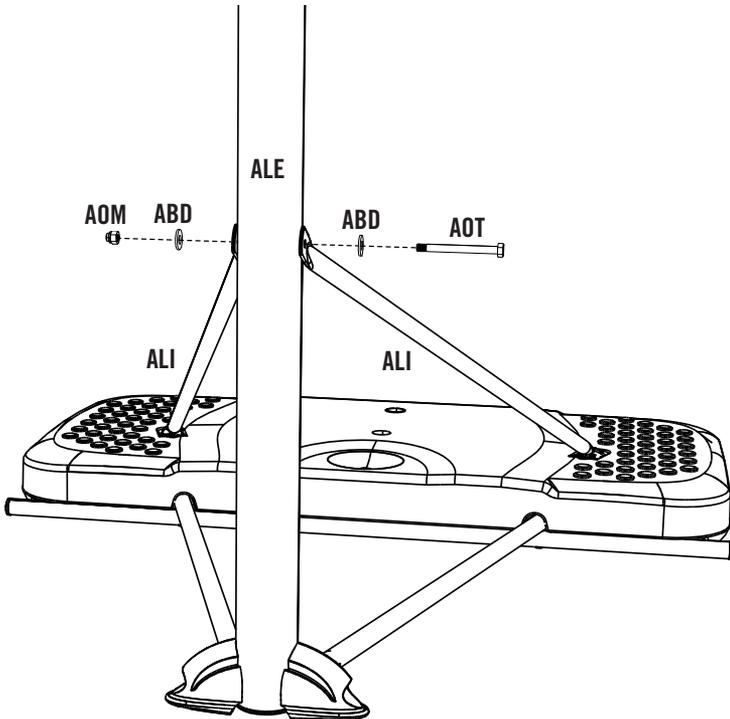

WARNING

Do not overtighten the Cap Nut.



TOOLS AND HARDWARE REQUIRED FOR THIS PAGE

NO TOOLS REQUIRED FOR THIS PAGE

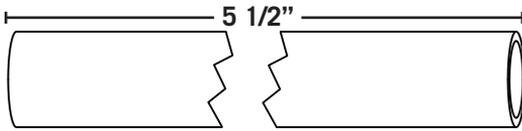

BFR (x2)

(Not actual length)

SEC

3.6

Insert the **1/2" x 5 1/2" Axles (BFR)** into each **Wheel (AMU)** as shown.

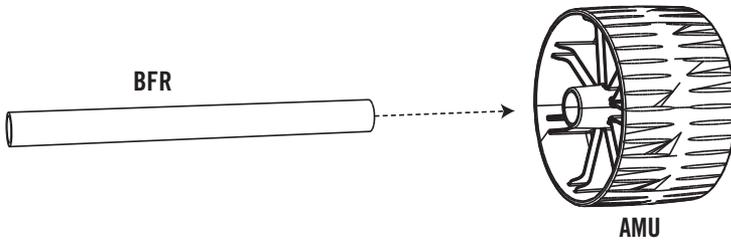

SEC

3.7

Place the Axle and Wheel Assemblies underneath the indentations at the back of the **Base (AJM)**. Then step on the Base to snap them in place.

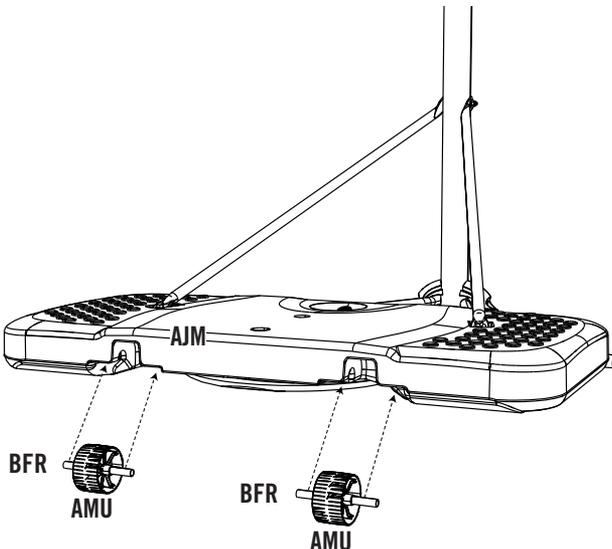

SEC 4 FINAL ASSEMBLY

HARDWARE REQUIRED

Hardware shown at Actual Size

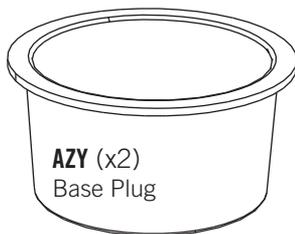

AZY (x2)
Base Plug

PARTS REQUIRED

Part shown at 10% of Actual Size

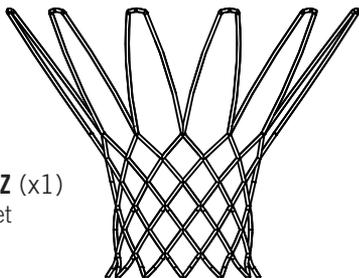

AKZ (x1)
Net

TOOLS REQUIRED



Funnel



Sand
(150 lb)



Water Hose



TOOLS AND HARDWARE REQUIRED FOR THIS PAGE



(150 lb)

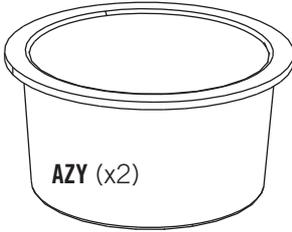

Two adults are required to complete assembly. To prevent serious injuries, the Pole should be held down by one adult at all times while the Base is being filled.

SEC

4.1

OPTION A: FILLING WITH SAND

(150 lb of sand required)

- Insert a **Base Plug (AZY)** into the **Base (AJM)** in the hole closest to the Pole.
- Using a funnel, fill the Base with sand through the hole furthest from the Pole until the sand is just below the hole.
- Using two adults, stand the Base up on a flat surface and finish filling the Base with sand.
- Insert the other Base Plug into the hole furthest from the Pole.



WARNING

For safety reasons, we recommend that sand be used instead of water to fill the Base. If a leak develops, water could run out unnoticed, allowing the system to fall over, resulting in serious personal injuries, or property damage. If using Water, check the Base carefully for leaks. If a leak is found, lay the system down on the ground and call Customer Service. Do not use, stand up, or play on a leaking system.

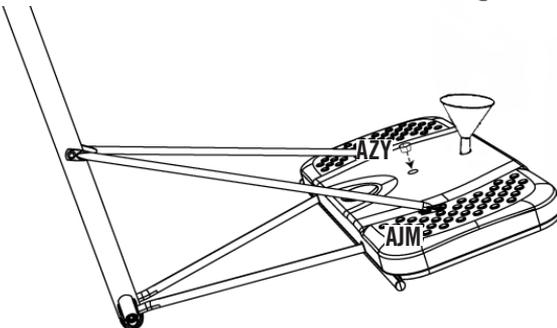



TOOLS AND HARDWARE REQUIRED FOR THIS PAGE

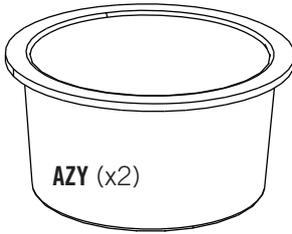

Two adults are required to complete assembly. To prevent serious injuries, the Pole should be held down by one adult at all times while the Base is being filled.

SEC

4.1

OPTION B: FILLING WITH WATER

- Insert a **Base Plug (AZY)** into the **Base (AJM)** in the hole closest to the Pole.
- Fill the Base with cold water through the hole furthest from the Pole until the water is just below the hole.
- Using two adults, stand the Base up on a flat surface and finish filling the Base with water.
- Add one tablespoon of chlorine bleach to the water to prevent algae formation.
- Insert the other Base Plug into the hole furthest from the Pole.





TOOLS AND HARDWARE REQUIRED FOR THIS PAGE

NO TOOLS OR HARDWARE REQUIRED FOR THIS PAGE

SEC

4.2

Attach **Net (AKZ)** to the **Rim (ALX)**.

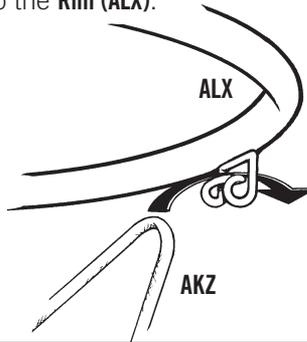

Note: If a replacement Net is needed, please call our Customer Service Department. Our Nets are shorter than average to reduce the risk of entanglement.

OPERATION OF HEIGHT ADJUSTMENT SYSTEM

The basketball system may be adjusted from 7 1/2 feet to 10 feet.
TWO ADULTS ARE NECESSARY TO ADJUST THE HEIGHT OF THE SYSTEM.

TO RAISE OR LOWER THE HOOP:

- Using at least two adults, tip the system backward and rest the Pole on a table. Do not scrape the powder coating off the Pole while adjusting the system, or you could void the product warranty and cause rusting.
- With one person holding the system at all times, remove the Adjustment Knob and the Carriage Bolt, adjust the system to the desired height and replace the Bolt and Knob.
- Make sure the Adjustment Knob is secure before standing the system back up to playing position.



MOVING THE SYSTEM

WARNING: The system must only be moved by people capable of handling its weight. Children should not be allowed to move the system.

- Adjust the system to its lowest position.
- Stand behind the system and pull on the Pole until the unit is balanced on its Wheels.
- Move the system to the desired location and carefully set the Base down.

CAUTION: The system must only be moved on its Wheels. Sliding the Base may damage the Base which could result in leakage and the system tipping over.

POLE CARE AND SYSTEM MAINTENANCE

The life of your basketball system depends on many variables. The climate, exposure to corrosives such as salt, pesticides, or herbicides, and excessive use or misuse can all contribute to Pole failure, which may cause property damage or personal injury.

Check your basketball system frequently for loose hardware, excessive wear, and signs of corrosion. For safety reasons, and to prolong the life of your basketball system, you must take the following preventive measures.

- a. Check all Nuts and Bolts. If any are loose, tighten them.
- b. Check all parts for excessive wear and tear. If necessary, replace any parts that have been worn or damaged through usage. Contact our Customer Service Department for replacement parts.
- c. Inspect the Warning Sticker on the Pole. If it is ripped, faded, or illegible, call our Customer Service Department to request a replacement Sticker.
- d. Check all Pole sections for visible rust or chipped or cracked paint. If either are present, do the following:
 1. Use an emery cloth to completely remove any rust or chipped paint.
 2. Clean the area with a damp cloth and allow it to dry.
 3. Apply two coats of a rust preventative, high gloss enamel paint to the area. Allow the paint to dry between coats.

IF RUST HAS PENETRATED THROUGH THE POLE ANYWHERE, REPLACE IT IMMEDIATELY!

NOTES

NOTES

NOTES

**ENHANCE YOUR LIFETIME® PURCHASE BY ADDING
ACCESSORIES OR OTHER GREAT PRODUCTS:**

To purchase accessories or other Lifetime Products, visit us at:

www.lifetime.com

Or call: 1-800-424-3865

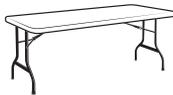



WARNING



FAILURE TO FOLLOW THESE WARNINGS MAY RESULT IN SERIOUS INJURY AND/OR PROPERTY DAMAGE.

Owners must ensure that all players know and follow these rules for safe operation of the system.

- Only hang from the rim briefly to regain balance or avoid injuring others. Release the rim as soon as safely possible.
- During play, especially when performing dunk type activities, keep player's face away from the backboard, rim, and net. Serious injury could occur if teeth/face come in contact with the backboard, rim, or net. Player should wear a mouth guard during play.
- Do not slide, climb, or play on base or pole.
- Completely fill base according to manufacturer's instructions. Never leave the unit standing in an upright position without first filling the base with weight or the system will tip quickly causing serious personal injury.
- When adjusting height or moving system, keep hands and fingers away from moving parts.
- Do not allow children to move or adjust system.
- Do not wear jewelry (rings, watches, necklaces, etc.) during play. Objects may entangle in net.
- Keep organic material away from pole base. Grass, litter, etc. could cause corrosion and/or deterioration.

- Surface beneath the base must be smooth and free of gravel or other objects. Punctures cause leakage and could cause system to tip over.
- Once a month check pole and all metal parts for signs of corrosion (rust, pitting, chipping). Completely remove rust and repaint with exterior enamel. If rust has penetrated any steel part, replace that part immediately.
- Check system before each use for proper ballast, loose hardware, excessive wear, instability, and signs of corrosion and repair before use.
- Never play on damaged equipment.
- Do not use system during windy or severe weather. System may tip over. Place system in an area protected from the wind or in an area away from property that may be damaged if the system falls, and from overhead power lines.
- Do not use the system to lift or hoist anything. The mechanism is designed to lift only the weight of the backboard and rim. Do not hang anything from the handle, rim backboard, or lifter arms as this will damage the system and void the warranty.



ADVERTENCIA



SI NO SE OBEDECEN ESTAS ADVERTENCIAS PUEDEN PRODUCIRSE GRAVES LESIONES Y/O DAÑOS A LA PROPIEDAD.

El propietario del sistema debe asegurarse de que todos los jugadores conozcan y respeten estas reglas para que el sistema se use en forma segura.

- Cuélguese del aro sólo en forma breve, para recuperar el equilibrio o evitar lesionar a otros jugadores. Suéltese del aro lo más pronto que pueda hacerlo con seguridad.
- Durante el juego, especialmente al embocar violentamente de alto, la cara de los jugadores debe mantenerse alejada del tablero, el aro y la red. Pueden producirse lesiones graves si los dientes o la cara entran en contacto con el tablero, el aro o la red. Los jugadores deben usar un protector bucal durante el juego.
- No se deslice, no trepe ni juegue sobre la base o el poste.
- Llene la base completamente siguiendo las instrucciones del fabricante. Nunca deje la unidad en posición de uso sin haber llenado previamente la base con material de contrapeso, pues el sistema podría tumbarse rápidamente y causar graves lesiones personales.
- Mantenga las manos y los dedos alejados de las piezas móviles cuando regule la altura o desplace el sistema.
- No deje que los niños regulen ni desplacen el sistema.
- No use joyas (anillos, relojes, collares o gargantillas, etc.) durante el juego. Estos objetos pueden engancharse en la red.
- La superficie donde se coloque la base debe estar lisa y desprovista de piedras, grava u otros objetos. Las perforaciones pueden originar pérdidas, y éstas pueden hacer que el sistema se tumbe.
- No permita que la base del poste entre en contacto con materiales orgánicos. El pasto, los desechos animales, etc., pueden causar corrosión y/o deterioros.
- Controle el poste y todas las piezas metálicas una vez al mes en busca de signos visibles de corrosión (oxidación, picaduras, escamado). Elimine todo rastro de óxido y vuelva a pintar con esmalte para exteriores. Si el óxido ha penetrado cualquier pieza de acero, reemplace esa pieza de inmediato.
- Inspeccione el sistema antes de cada uso para verificar que esté adecuadamente contrapesado, que los elementos de fijación no estén flojos, que no haya desgaste excesivo, inestabilidad ni signos de corrosión. Si encuentra irregularidades, repárelas antes de usar el sistema.
- Nunca juegue con un equipo dañado.
- No use el sistema en presencia de vientos fuertes o condiciones climáticas adversas, ya que puede tumbarse. Coloque la unidad en su posición de almacenamiento y/o en una zona a resguardo del viento, lejos de propiedades personales que puedan dañarse si el sistema se cae, y de líneas de suministro de energía.
- No use el sistema para levantar ningún objeto. El mecanismo está diseñado para elevar solamente el peso del tablero con el aro. No cuelgue nada de la agarradera, el aro, el tablero ni los brazos de elevación, ya que esto puede dañar el sistema y anular la garantía.

AVERTISSEMENT



FAUTE DE NE PAS SUIVRE CES AVERTISSEMENTS, VOUS RISQUEZ DE CAUSER DES BLESSURES GRAVES ET/OU DES DOMMAGES À L'ÉQUIPEMENT.

Le propriétaire doit s'assurer que tous les joueurs connaissent et appliquent les règles suivantes afin d'utiliser l'équipement en toute sécurité.

- Ne vous suspendez pas à l'anneau plus que nécessaire pour retrouver votre équilibre ou éviter de blesser les autres joueurs. Relâchez l'anneau aussitôt que possible.
- Lors d'un match, particulièrement dans le cas des smashes, le visage du joueur ne doit pas faire face au panneau, à l'anneau, ni au filet. Le joueur risque de graves blessures si ses dents ou son visage entrent en contact avec le panneau, l'anneau, ou le filet. Les joueurs doivent toujours porter un protège-dents lorsqu'ils jouent.
- Ne glissez pas, ne grimpez pas, et ne jouez pas sur la base ou le poteau.
- Remplissez complètement la base selon les instructions du fabricant. Ne laissez jamais l'unité debout de plein pied sans avoir d'abord rempli la base avec un poids ou l'équipement pourrait basculer rapidement et causer de graves blessures.
- Lorsque vous ajustez la hauteur ou lorsque vous déplacez l'équipement, gardez vos mains et doigts loin des pièces mobiles.
- Ne permettez pas aux enfants de déplacer ou d'ajuster l'équipement.
- Ne portez pas de bijoux (bagues, montres, colliers, etc.) lorsque vous jouez. Ces objets pourraient s'accrocher au filet.
- La surface sur laquelle est posée la base doit être lisse et sans gravier ou tout autre objet qui pourrait troubler la base entraînant ainsi une fuite ce qui pourrait faire basculer l'équipement.
- La base ne doit pas non plus être posée sur aucun type de matière organique. L'herbe, les déchets, etc. peuvent entraîner la corrosion et la détérioration de l'équipement.
- Une fois par mois, vérifiez que le Poteau et toutes les pièces en métal ne montrent pas de signes de corrosion (rouille, piqûres, écaillage). Enlevez toute la rouille et repeignez complètement avec une peinture pour extérieur. Si la rouille a pénétré une des pièces en acier, vous devrez remplacer immédiatement la pièce en question.
- À chaque fois que vous allez utiliser l'équipement, vérifiez d'abord l'équilibre, la possibilité de pièces desserrées ou usées, la stabilité de l'équipement et tout signe de corrosion ou réparation nécessaire avant utilisation.
- Ne jouez jamais avec un équipement endommagé.
- N'utilisez pas l'équipement lors de fortes rafales de vent ou de mauvais temps. L'équipement pourrait basculer. Placez l'équipement dans un endroit abrité du vent ou loin des structures qu'il pourrait endommager s'il basculait et loin des fils électriques.
- N'utilisez pas l'équipement pour lever ou soulever quoique ce soit. Son mécanisme a été conçu uniquement pour soutenir le poids du panneau et de l'anneau. N'accrochez rien au manche, à l'anneau, au panneau ni aux leviers sous peine d'endommager l'équipement et d'annuler la garantie.

WARRANTY INFORMATION

LIFETIME BASKETBALL EQUIPMENT

5-YEAR LIMITED FACTORY WARRANTY

THE MANUFACTURER RESERVES THE RIGHT TO MAKE SUBSTITUTIONS TO WARRANTY CLAIMS IF PARTS ARE UNAVAILABLE OR OBSOLETE.

1. Lifetime basketball systems are warranted to the original purchaser to be free from defects in material or workmanship for a period of five years from the date of original retail purchase. The word "defects" is defined as imperfections that impair the use of the product. Defects resulting from misuse, abuse or negligence will void this warranty. This warranty does not cover defects due to improper installation, alteration or accident. This warranty does not cover damage caused by vandalism, rusting, "acts of nature" or any other event beyond the control of the manufacturer.
2. This warranty is nontransferable and is expressly limited to the repair or replacement of defective basketball equipment. If the equipment is defective within the terms of this warranty, Lifetime Products, Inc. will repair or replace defective parts at no cost to the purchaser. Shipping charges to and from the factory are not covered and are the responsibility of the purchaser. Labor charges and related expenses for removal, installation or replacement of the basketball system or its components are not covered under this warranty.
3. This warranty does not cover scratching or scuffing of the product that may result from normal usage. In addition, defects resulting from intentional damage, negligence, unreasonable use or hanging from the net or rim will void this warranty.
4. Liability for incidental or consequential damages is excluded to the extent permitted by law. While every attempt is made to embody the highest degree of safety in all equipment, freedom from injury cannot be guaranteed. The user assumes all risk of injury resulting from the use of this product. All merchandise is sold on this condition, and no representative of the company may waive or change this policy.
5. This product is not intended for institutional or commercial use; Lifetime Products, Inc. does not assume any liability for such use. Institutional or commercial use will void the warranty.
6. This warranty is expressly in lieu of all other warranties, expressed or implied, including warranties of merchantability or fitness for use to the extent permitted by Federal and state law. Neither Lifetime Products, Inc., nor any representative assumes any other liability in connection with this product. This warranty gives you specific legal rights, and you may also have other rights which vary from state to state.

ALL WARRANTY CLAIMS MUST BE ACCOMPANIED BY A SALES RECEIPT.

REPORT PRODUCT DEFECTS IN WRITING TO:

Lifetime Products, Inc., PO Box 160010 Clearfield, UT 84016-0010, or call (800) 225-3865

M-F 7 a.m. to 5 p.m. MST.

****Call or visit our Web site for Saturday hours****

Please include your dated sales receipt and photographs of damaged parts.

To register the product, visit our Web site at www.lifetime.com



www.lifetime.com